

User manual

Power quality analyser and smart meter

ARTIQ 233

Document revision	Release date	Valid for versions			
		Hardware	Bootloader	Firmware	Software ENVIS
1.7	22.4.2021	2.0	4.2	4.0	2.0
1.6	10.6.2019	2.0	4.0	3.0	1.8

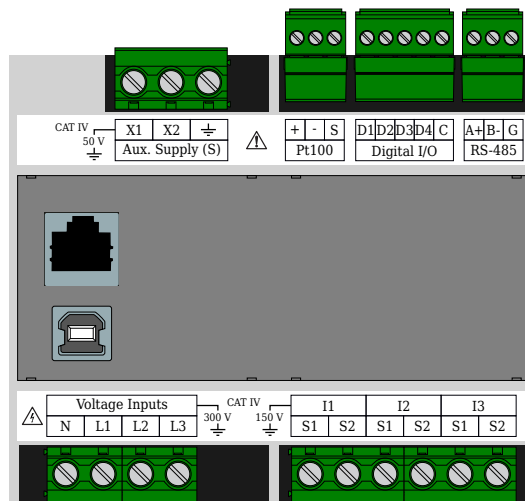

Figure 1: ARTIQ 233(D) S X/5A E

Contents

1	Basic description	3
1.1	Types and options	3
1.2	News in version 3.0	3
1.3	Accessories	4
1.4	Measuring principles and signal processing	4
2	Operating the measuring instrument	6
2.1	Safety requirements for use of the ARTIQ 233	6
2.1.1	The meaning of the symbols used on the device	6
2.2	Installing the device in a switchboard	7
2.2.1	Auxiliary voltage	7
2.2.2	Measured voltages	8
2.2.3	Measured currents	8
2.2.4	Connection of communication channels	9
2.2.5	Inputs and outputs	12
2.3	Description of LED indicators (does not apply to ARTIQ 233D)	13
2.4	Detailed instrument settings on the PC	13
2.4.1	Installation (obr. 13a)	15
2.4.2	Date and time (fig. 14)	17
2.4.3	Aggregation (averaging, fig. 15)	18
2.4.4	Communication (fig. 16)	19
2.4.5	I/O Management (fig. 17)	20
2.4.6	Memory (fig. 18)	20
2.4.7	Setting the main archive (Archive 1, fig. 19).	20
2.4.8	Electricity meter (fig. 20)	22
2.4.9	Modules (fig. 21)	23
2.5	Setting measurement identification	23
2.6	Transfer of measured data to PC	23
2.7	Display of electricity meter reading	24
2.8	Embedded Web server	25
3	Technical parameters	26
3.1	Basic parameters	26
3.2	Measured quantities	28
3.3	Inputs and outputs	31
3.4	Power quality and energy management	32
4	Maintenance, service and warranty	36

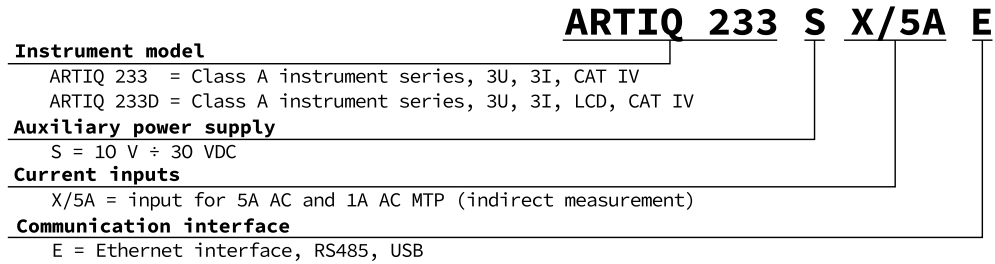

Figure 2: Ordering codes and schemas.

1 Basic description

ARTIQ 233 is designed to remotely monitor power consumption and voltage quality. It is designed for installation on a din rail or mounting panel and does not have a local display in the basic version. This concept is suitable for a wide range of applications in power engineering and smart networks, in building automation and individual production processes, for remote infrastructure supervision and also for automatic load management. The device is not equipped with local controls and therefore cannot easily interfere with the functions it performs - in simple terms, it should not attract the special attention of people in easily accessible installations. To protect settings and collected data, the device can be locked with a pin or password.

Inputs and outputs can be easily set to control simple control tasks. It uses the RS-485 or Ethernet communication line for connection to a remote control systems. The USB is designated for local configuration and occasional downloads. The instrument measures three voltage and three current channels.

1.1 Types and options

The ARTIQ 233 is available in various configurations according to the customer's specifications¹. On figure 2 marking schema of all available options is drawn. The device is always equipped with four universal digital inputs/outputs and an external Pt100 temperature sensor input.

1.2 News in version 3.0

- more accurate measurements and higher accuracy classes than previous versions
- measurement of common DC quantities, measuring systems with non-standard nominal frequency e.g. 16²/3 Hz, 80 Hz, 400 Hz or frequency inverters up to $f_{nom} = 500 Hz$
- four quadrant measurement of powers and energies, booth active and reactive
- extended, more accurate and continuous measurement of harmonic phasors (amplitudes and angles)
- possibility to synchronize device time from network frequency, NMEA, PPS, PPM,
- modular firmware - modules for Power Quality, General Oscillogram, RCS/HDO, ModBus Master, Ethernet-Serial, UDP Push
- PQ module:
 - optional measurement and evaluation of power quality according to EN 50160
 - class A voltage quality measurements according to IEC 61000-4-30 ed. 3
 - inter-harmonic measurements according to 61000-4-7 ed. 2
 - flicker measurements P_{inst} , P_{st} a P_{lt} class F1 according to IEC 61000-4-15 ed. 2
 - voltage events: voltage dips/sags, swells, over- and under-voltages, etc.
- RCS module:

¹A complete and up-to-date list of optional accessories can be obtained from your dealer upon request.

Table 1: Standard and optional accessories

Ordering code	Accessory		Description
	Standard	Number of pcs.	
BC 17,6 BS U11 KMGY	☑	1	Cover for enclosure
726 141 001	☑	1	Cover for USB
726 154 101	☑	1	Cover for Ethernet
USB 2.0 A-B, 2 m	☒		USB cable

- measuring, evaluating and recording telegrams of the RCS (ripple control) system.
- UP module:
 - for easier upload or push of data into remote control systems.
- Status:
 - added features for remote analysis of communication and device operating states.
- Firmware Upgrade: This feature has been significantly enhanced. The device now remembers its complete factory settings and firmware, as well as the latest working (stored) and most up-to-date one.
- Email Alarm: added the ability to automatically send email to specified addresses when an event occurs, see AppNote 0003.
- Locking the device: new features for user access management have been added (see AppNote 0004).

1.3 Accessories

In table 1 is a list of accessories that are automatically delivered to each ARTIQ 233 and accessories that can be specified when ordering or additionally purchased.

1.4 Measuring principles and signal processing

Connection and measurement

- DC supply voltage $10 \div 30$ V
- three voltage inputs (L_1, L_2, L_3) for direct or indirect measurement of star or delta voltage, single-phase and Aron
 - wide range of supported nominal voltages, for direct or indirect measurement
 - measurement category IV/300V
- three current inputs (I_1, I_2, I_3) for indirect measurement
 - standard variant X/5A - inputs for measurement with common current transformers with rated current of secondary winding 5 A or 1 A
 - measurement category III/300V
- 28.8 kHz sampling, continuous measurement of voltage and current inputs
- calculate 128 components of harmonic voltages and currents
- evaluation of all commonly measured single- and three-phase quantities such as power (active, reactive, apparent, deformation and fundamental active and reactive power), power factors, harmonics and THD for voltages and currents, ...
- four digital universal inputs / outputs
- input for temperature measurement with external Pt100 sensor
- functions can be extended with external I/O modules (with ModBus Master module and with MIO devices)

Measured data recording

- built-in precise real time circuit with backup battery
- memory for recording measured data and events with a capacity of 512MB
- individual archives can get dynamically allocated storage capacity
- aggregation interval from 200ms to 24hours

Data transmission and evaluation

- ENVIS 1.8 or higher is available for free download
- system service ENVIS.Online for downloading and processing of archived measurement data
- tools for downloading, exporting and processing data using custom scripts or via command line
- data library for developing custom applications in C # /. NET or for Linux (C / C ++, .NET Core)
- for data transfer, instrument setting and firmware update, the RS-485, Ethernet and USB communication interfaces are used

Supported firmware modules

- Power Quality (PQ) - Extends analyzer features with new quantities (inter-harmonic, flicker, selective voltmeter/RCS). It also adds the EN 50160 power quality archive and voltage event archive. Thus, with activation of the PQ module the ARTIQ 233 becomes a full-fledged Class A power quality analyzer..
- General Oscillograms (GO) - Adds the ability to record transients in form of raw samples of measured voltage and current signals.
- Ripple Control Signals (RCS) - Allows you to record telegrams of remote remote control (RCS) and their voltage levels.
- ModBus Master (MM) — allows regular downloading of data from ModBus-enabled devices to its own memory.
- Ethernet-Serial (ES) — communication converter between remote control system 9ETH0 and one or more slave units on the local RS-485 line.
- UDP Push (UP) — allows reading of archived data by Modbus TCP or RTU protocol and also active upload (push) of data via Ethernet by UDP protocol to a dedicated server (does not require control of communication from the server side).

A detailed list of the technical parameters of the device is given in the chapter 3.

2 Operating the measuring instrument

2.1 Safety requirements for use of the ARTIQ 233



When working with the device, all necessary precautions must be taken to protect persons and property against injury and electric shock.

- Danger of electric shock! Do not open the device!
- The device must be operated by a person with the required qualifications for such operation and this person must be familiar with the principles of working with the device described in this description.
- Follow the user manual and keep it with the device.
- Only connect the device as described in the instructions and in a de-energized state.
- Do not use the device in an explosive atmosphere.
- Make sure that the device is not operated outside the limits. See technical parameters.
- The device is cleaned when switched off with a dry cloth or brush.
- If the unit is connected to parts that are under dangerous voltage, all necessary precautions should be taken to protect users and equipment from electric shock.
- The operator performing installation or maintenance of the equipment must be equipped with personal protective equipment and other safety equipment at work.
- If the analyzer is used in a manner not specified by the manufacturer, the protection provided by the analyzer may be reduced.
- If the analyzer or its accessories appear to be damaged or not working properly, do not use it and send it for repair.
- Repairs to the device may only be carried out by the manufacturer or a service organization authorized by him.

2.1.1 The meaning of the symbols used on the device

Table 2: Symbols

Symbol	Description
	Warning
	Warning, possibility of electric shock
	Alternating current
	Direct current
	CE mark declaring conformity with European regulations and regulations
	The device must not be disposed of with household waste
	Equipment with double or reinforced insulation
	USB communication interface

2.2 Installing the device in a switchboard

The ARTIQ 233 is designed for mounting on a DIN rail. In the figure 3, the dimensions of the device are drawn. The hole positions for the wall mounting are dimensioned by a dashed line, which is screwed with three screws. The maximum cable cross-section for all device screw terminals is 4 mm^2 (power, voltage, currents) or 1.5 mm^2 (communication, inputs, outputs, thermometer).

Natural air circulation should be allowed inside the switchgear at the installation site and its immediate surroundings. Do not install other equipment that could be a significant source of heat near to the instrument.

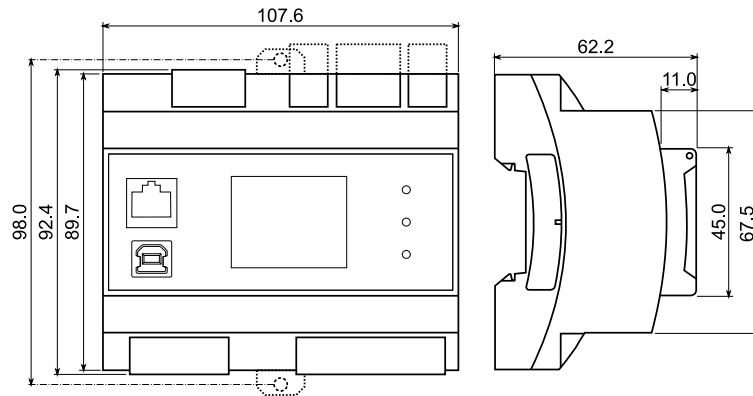

Figure 3: Dimensions of ARTIQ 233.

2.2.1 Auxiliary voltage



The device only has a low voltage power supply (option S) input. Caution should be taken when selecting a suitable power supply.

The instrument supply voltage must be connected to the terminals X1 and X2 via suitable fuses with appropriate characteristics for the respective environment (see diagram in figure 4 for power off). The disconnecter must be located on the left side of the device within reach of the operator. The circuit breaker must be marked as a disconnect switch. A 0.5A circuit breaker is a suitable circuit breaker, but its location and function must be clearly identified (using the '0' and 'I' symbols according to EN 61010-1). The power supply galvanically separates the power terminals of the device from other internal circuits.

In addition to terminals X1 and X2, the terminal block Aux. supply (S) also contains a functional ground terminal. This terminal is not important for the safety of the device (ARTIQ 233 is designed as a double / reinforced insulation device), but it affects the behavior of unconnected voltage inputs (measures zero voltage) and reduces the strain on insulating barriers in case of transient phenomena in the network, thus increasing durability and reliability of the instrument. In TN and TT networks, this terminal must be connected to a ground conductor (TN-S) or PEN conductor (TN-C). In the case of IT installation, it is not necessary to connect the terminal if it is desired to minimize the effect on network isolation.

Recommended type of conductor	H07V-U (CY)
Recommended minimum conductor cross-section:	$0,75\text{ mm}^2$
Maximum conductor cross section:	4 mm^2

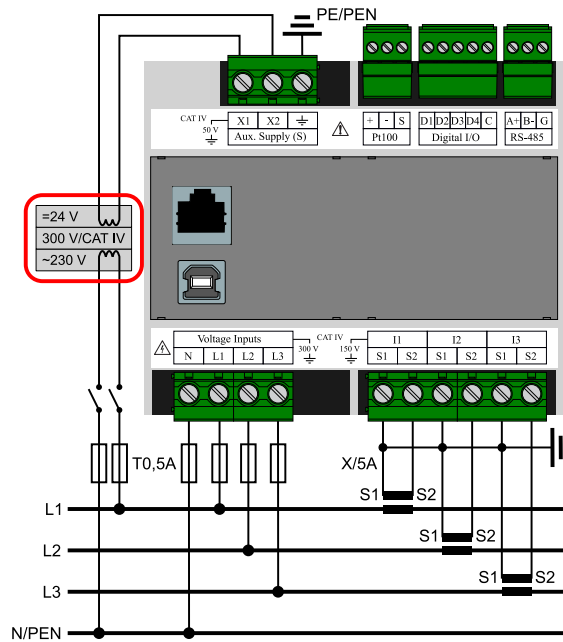

Figure 4: In a 300V/CAT IV network it is necessary to use a power supply with the corresponding overvoltage category! Our PWR1 or PWR3 smart grid power supply is conforming to this requirement.



The device as a whole is intended for measurement in networks of overvoltage category up to 300 V/CAT IV, provided that it is supplied from low voltage (SELV) with power supply with reinforced insulation for overvoltage category 300V/CAT IV see picture 4.

2.2.2 Measured voltages

Overvoltage category signals 300 V/CAT IV can be directly connected to the voltage measurement inputs.

The measured voltages are connected to terminals L1, L2 and L3. The center conductor connection terminal is marked N - when connected to a triangle and not connected in Aron's wiring. All voltage measuring inputs are connected to the internal circuits via high impedance.

Measured voltages should be protected, for example, by a 0.5A fuse with a suitable tripping characteristic. Measured voltages can also be connected via instrument (measuring) voltage transformers, especially in MV and HV networks.

Recommended type of conductor	H07V-U (CY)
Recommended minimum conductor cross-section:	0,75 mm ²
Maximum conductor cross section:	4 mm ²

2.2.3 Measured currents

Overvoltage category signals can be directly connected to the current measurement inputs 150 V/CAT IV. In case of connection according to figure 5 it is possible to connect to 300V/CAT IV.

The instrument is designed for indirect current measurement via external current transformers (CTs). The CT orientation (terminals S1 and S2) must be observed during installation. Accuracy can be verified by knowing the current active energy transfer direction according to the sign of the respective active power or by the phasor diagram on a display or by using the ENVIS.Daq software.

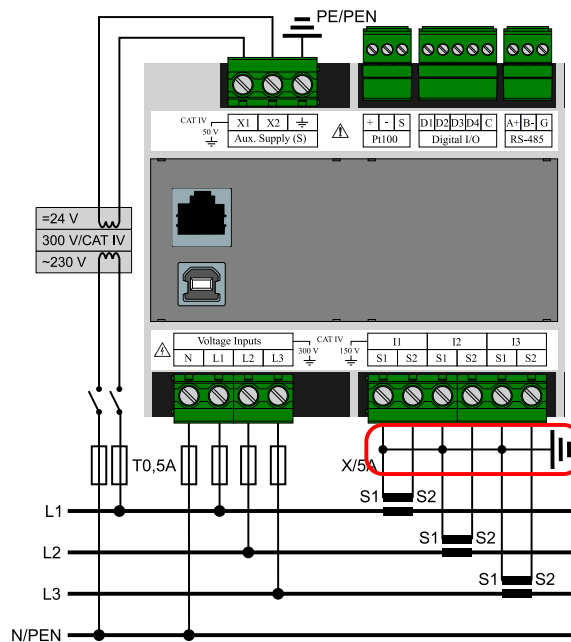

Figure 5: In a 300 V/CAT IV network, one of the secondary terminals of each CT must be grounded!



The device as a whole is intended for measurement in networks with overvoltage category of up to 300 V/CAT IV, provided that the S1 (or S2) terminals of all corresponding CTs are grounded at one point, see figure 5.

Option „X/5A“ The secondary CT winding of nominal 5 A or 1 A must be fed to the terminals S1 and S2 of the current inputs I1, I2 and I3. Figure 6 illustrates the correct connection with the CTs in the LV network. In the figure 7, there is an example of a HV network using an Aron circuit where I2 inputs remain unconnected. In MV/HV networks, it is always necessary to ground the S1 (or S2) terminals of all CTs at one point.

Recommended type of conductor: H07V-U (CY)
 Recommended minimum conductor cross-section: 2,5 mm²
 Maximum conductor cross section: 4 mm²

2.2.4 Connection of communication channels

All the peripherals listed below are galvanically isolated from the rest of the device and from each other.

USB The USB communication interface is used for local parameterization of the instrument and easy and fast reading of the recorded data. The USB-B connector is located on the front panel of the machine. ARTIQ 233 is a USB 2.0 device.

Always use the supplied USB cable (USB-A/USB-B) to connect to a PC.

Ethernet The 100Base-T Ethernet Interface Module with RJ-45 connector marked as ETH is located on the front panel of the instrument. It performs the same functions as primary RS-485 to connect to a TCP/IP network. It can also be used for easy and fast connection to a remote computer.

The type and maximum length of the required cable must match IEEE 802.3.

RS-485 It is usually used as an interface for remote reading of current values, archive records, and instrument settings. The RS-485 serial line uses the A +, B-, and G-signal terminals on the terminals described by RS-485 (fig. 8). The ends of the communication line must be terminated with the specified resistance.

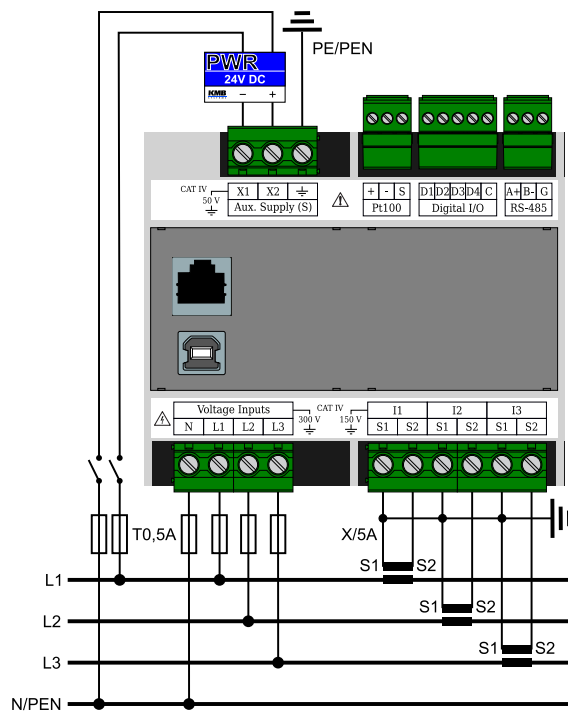

Figure 6: An example of a typical connection of ARTIQ 233 in a LV network - wiring a measured voltage to a star in a four-wire network.

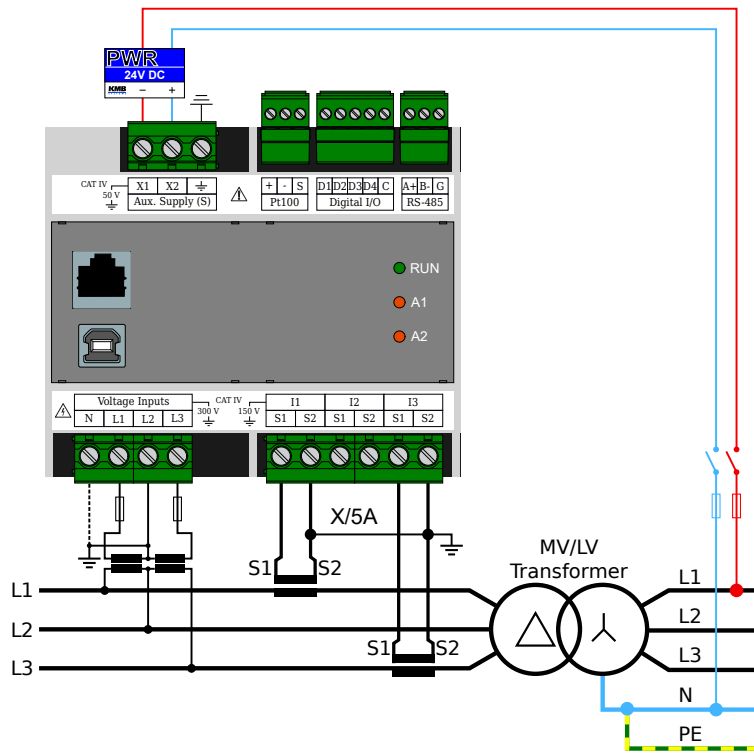

Figure 7: An example of a typical instrumentation of ARTIQ 233 when measured in a MV, HV network on the secondary side of an instrument transformer.

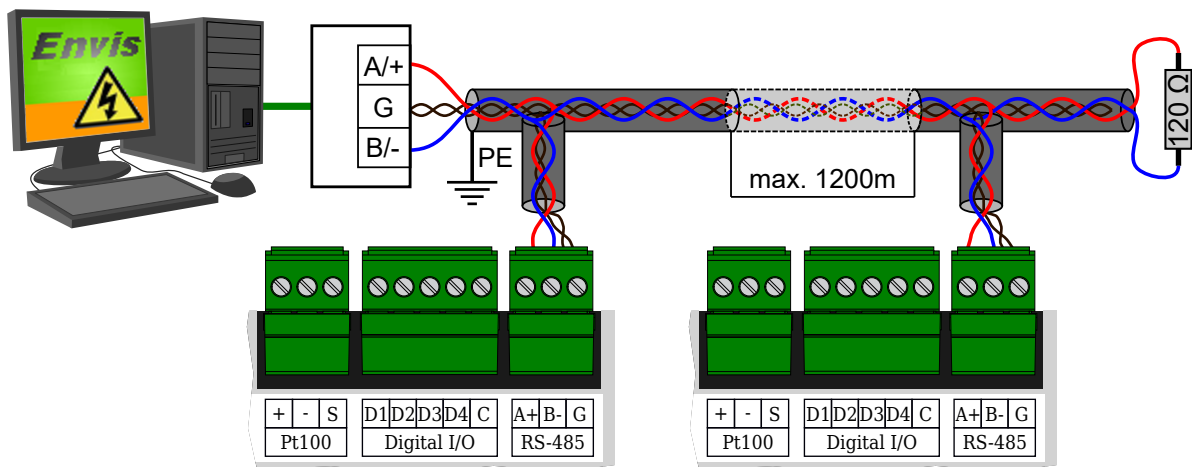

Figure 8: Connection of RS-485 communication lines to ARTIQ 233 devices ARTIQ 233.

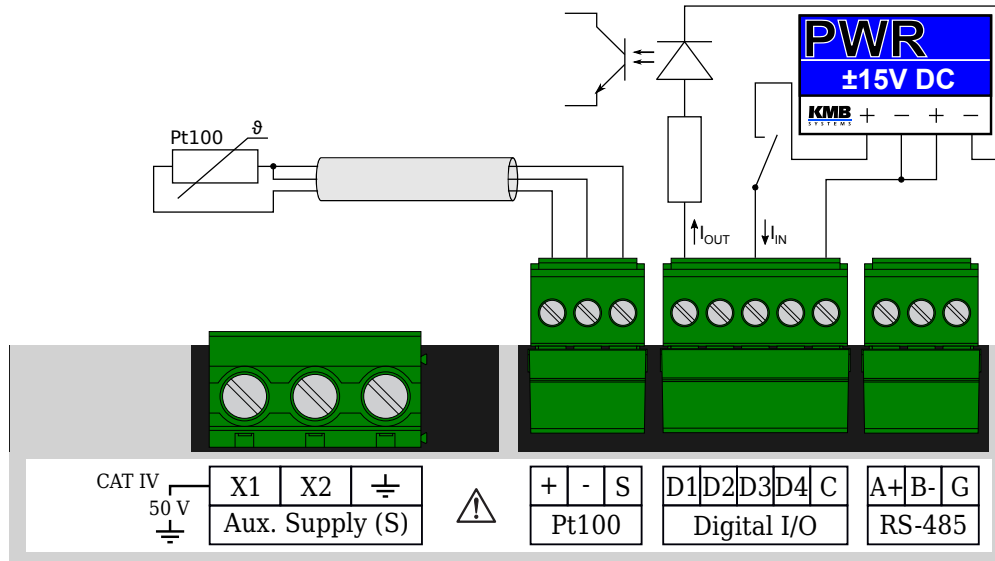

Figure 9: Connection of inputs and outputs in the device ARTIQ 233.

For common use (cable length up to 100 m, communication speed up to 9600 Bd), the choice of cable type is not critical. It is possible to use virtually any shielded cable with two pairs of conductors and to connect the shield at one point to the PE conductor. If the cable length is over 100 m, or when the communication speed is higher (about 20 kbit/s), it is advisable to use a shielded communication cable with twisted pairs (so-called "twisted pair"), which has a defined wave impedance (usually about 100 Ω). Signals A and B are connected by one pair, signal G by the other pair.

The RS-485 interface requires impedance termination of the end nodes using terminating resistors, especially at higher communication speeds and distances. Terminating resistors are only installed at the end points of the line (eg one at the PC and the other at the most remote device). They are connected between terminals A and B. A typical value of the terminating resistor is 120 Ω.

Recommended type of conductor	shielded twisted pair 2×2×0,2 mm ² , e.g. Belden 9842
Recommended minimum conductor cross-section:	0,2 mm ²
Maximum conductor cross section:	1,5 mm ²

2.2.5 Inputs and outputs

The device is equipped with four universal unipolar inputs/outputs (I/O). It is possible to connect and configure any I/O combination. Universal I/O is designed for monitoring and switching signals with voltage up to 30 V.



By selecting the wiring polarity, the individual I/O D1 to D4 can be used in either input mode or output mode. I/O are designed as unipolar to minimize the risk of destroying the output switching element in the event of an installation error or setting when a voltage from an external source is connected to the digital output in the same way as a digital input (without serial impedance). In this case, the switching element may be damaged if it is closed.

Digital input mode

For use in digital input mode it is necessary to connect positive voltage to terminal D1, D2, D3 or D4 to common terminal C. Voltage lower than 3 V_{DC} connected between Di and C is evaluated as in state, voltage higher than 7 V_{DC} is evaluated as active state. On fig. 9 is an example of connecting terminal D3 in digital input mode to monitor external contact closing.

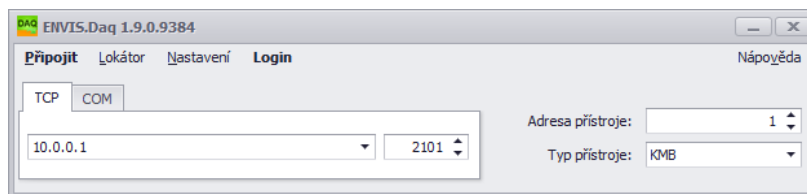

Figure 10: Main window of ENVIS.Daq application after its launch — select the type of communication used, set its parameters and press Connect in menu to continue.

Digital Output Mode

For use in digital output mode, it is necessary to connect the positive voltage to common terminal C to D1, D2, D3 or D4, where the load is connected in series. An external voltage source must be connected in the circuit (we recommend $24 V_{DC}$). The polarity of the external voltage source must correspond to the figure 9. The D1 terminal is used in the digital output mode to control the external optocoupler.

Recommended type of conductor	H07V-U (CY)
Recommended minimum conductor cross-section:	$0,2 \text{ mm}^2$
Maximum conductor cross section:	$1,5 \text{ mm}^2$

2.3 Description of LED indicators (does not apply to ARTIQ 233D)

Function of the red LED alarm diodes $A1$, $A2$ can be configured in the IO section of instrument configuration.. The green *Run* LED is used to indicate the correct program run:

3 s on, 1 s off is a normal state of the instrument

0.2 s on, 0.2 s off indicates a special status of 10s after power up. During this interval, the device listens to the RS-485 interface in addition to its set address at address 250. Fast flashing can be used to visually check the device restart when the power supply is disconnected/connected, when a change of settings is required that requires a reboot or a firmware upgrade.

During the firmware upgrade, all three LEDs flash together. The states are as follows:

Slow blinking means that instrument restarted and is now in bootloader

Steady on for a few seconds indicates operations with the internal storage.

Fast blinking indicates uploading of the new firmware

2.4 Detailed instrument settings on the PC

It is advisable to set the ARTIQ 233 instrument before starting the measurement. The settings can be made from the computer in the ENVIS².



Changes to the device settings will erase all data stored in the device memory. Make sure that the previous data is backed up before changing the settings.

1. Turn the power on. Its presence will be indicated by the flashing green PWR LED or the backlight on. If everything is OK, the instrument will go through the start phase and display the set start screen.
2. Connect ARTIQ 233 to a computer via RS-485, USB³ or Ethernet. The device is now ready for configuration.
3. Run the ENVIS.Daq application and select the correct tab according to the communication interface type (Fig. 10).

²Daq application. ENVIS.Daq is also part of the ENVIS installation package. A detailed description can be found in the ENVIS user manual.

³If you connect a similar device to a computer via USB for the first time, it is necessary to install a USB device driver for Windows first. You can find it on the manufacturer's website and also in the driver directory in the folder where the ENVIS program is installed. For example, here: 'C:\Program Files (x86)\KMB systems\ENVIS 1.2\driver'.

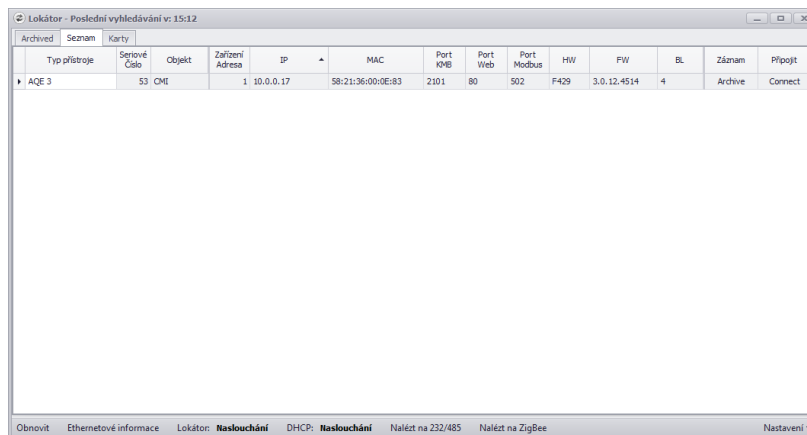

Figure 11: Window of the *Locator* tool — automatically searches for supported devices in the network environment of the computer.

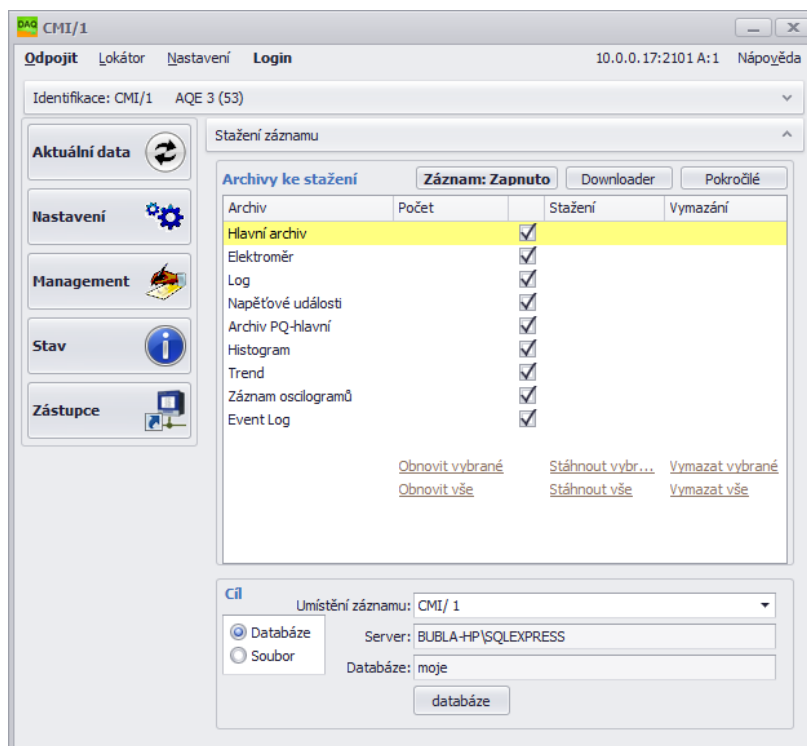

Figure 12: ENVIS.Daq application window with connected analyzer.

4. Fill in the communication link parameters

- (a) USB: select the corresponding virtual serial port from the list
 - (b) RS-485: Immediately after start, the green *Run* LED flashes quickly (once in 400 ms). The next 10 seconds the device waits for service communication — it communicates with a fixed baud rate of 9600 Bd and also listens at address 250. If ARTIQ 233 does not receive any command at this time, the communication port will be reset to the current configuration and go to normal mode. If the communication occurs, the service communication will be extended by 60 s after each processed message. ARTIQ 233 also listens on the user-set address through the start time so that it is possible to communicate with the device immediately after power-up. The end of booting is indicated by a slow blinking green *Run* LED (once every 4 s). Select the appropriate serial port from the list and set the communication speed.
 - (c) Ethernet: fill in the IP address and communication port (10.0.0.1:2101 by default). If you do not know the correct values, try using the *Locator*⁴ function.
 - (d) Fill in the device address according to the settings — *1* by default.
 - (e) Select *Device Type* KMB.
5. Press *Connect* on menu or *ENTER*. The application attempts to connect to the specified device. If the connection is successful, it loads the settings stored in the device and displays a summary window (fig. 12).
 6. Press the *Configs* button in the left column of the menu. A new window with device settings tabs appears.

The *Instrument Configuration* contains individual tabs with device parameters divided by meaning. User can change any parameters in individual tabs. Changes to settings are made only in the application and uploaded to the device by pressing the *Send* button. The *Receive* button can be used to retrieve the current valid settings from the device at any time. Bookmarks that have been changed locally and have not yet been written to the device are marked with a warning symbol. The *Save* and *Load* buttons are used to archive the current settings to or from a file.

In particular, the *Installation* and *Time and Date* tabs are essential for proper operation.

2.4.1 Installation (obr. 13a)

- *Nominal frequency* — set according to the nominal frequency of the measured network (50 or 60Hz). This setting also affects how the power quality is evaluated.
- *Connection mode* — Sets how the device is connected either as a voltage measurement directly or via a voltage measuring transformer (usually a HV and VHV network).
- *Connection type* — connection method in one- and three-phase systems — star, delta and Aron connection. The connection options for the analyzer are illustrated in Fig. 13, 13c and 13d.
- U_{NOM} , P_{NOM} (nominal voltage and power) — Correct setting of U_{NOM} and P_{NOM} affects the relatively displayed values of voltage, power and current, the operation of some alarm functions and IOs, and interpretation of measurements in ENVIS.
 - U_{NOM} determine according to the nominal voltage of the measured network.
 - P_{NOM} set at the measuring point according to the nominal power of the power transformer, circuit breaker or installed protection.
- VT, VTN ratio — if the *connection mode via VT* is selected, the conversion according to the used voltage transformers must also be set. The ratio you enter is:
 - Rated primary voltage: usual value is 22 000.
 - Nominal secondary voltage: usual value is 100 (other common 110, 120, 230 V, ...)

⁴The locator is used to locate all supported devices in the surrounding network or on a serial line. Warning: it contains functions (such as a local DHCP server), which sometimes need to be enabled in the Firewall settings and which may also affect the functionality of other devices on the network. (fig. 11)

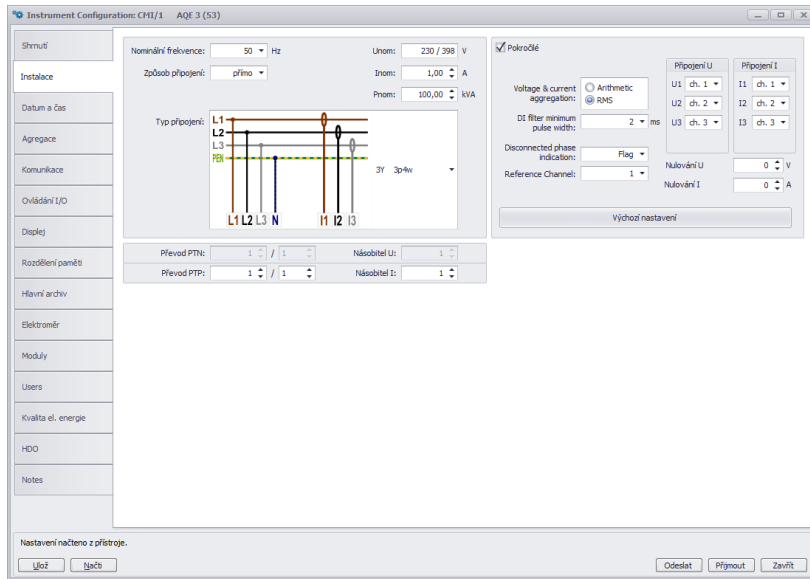

(a) Setting of basic device connection parameters in ENVIS.Daq application.

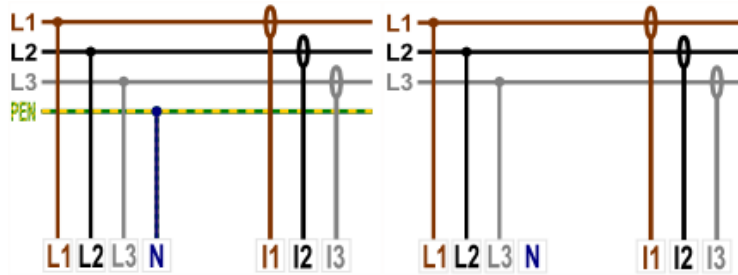

(b) Connection types of devices in LV networks (direct connection).

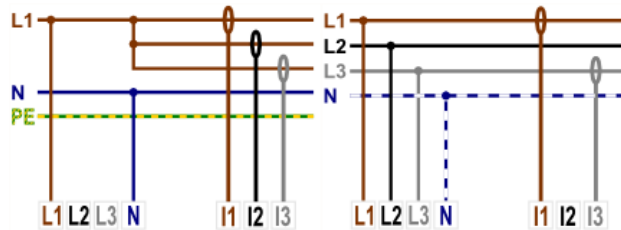

(c) Special connection options in LV networks — single-phase measurement of up to three channels and three-phase measurement in Aron.

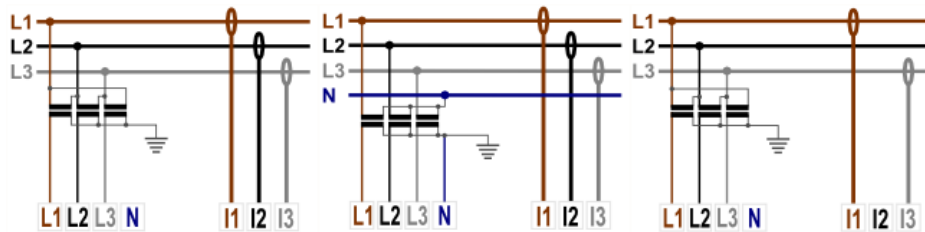

(d) Indirect connection of devices via voltage measuring transformer (in HV, HV networks, etc.).

Figure 13: ENVIS.Daq — device installation settings.

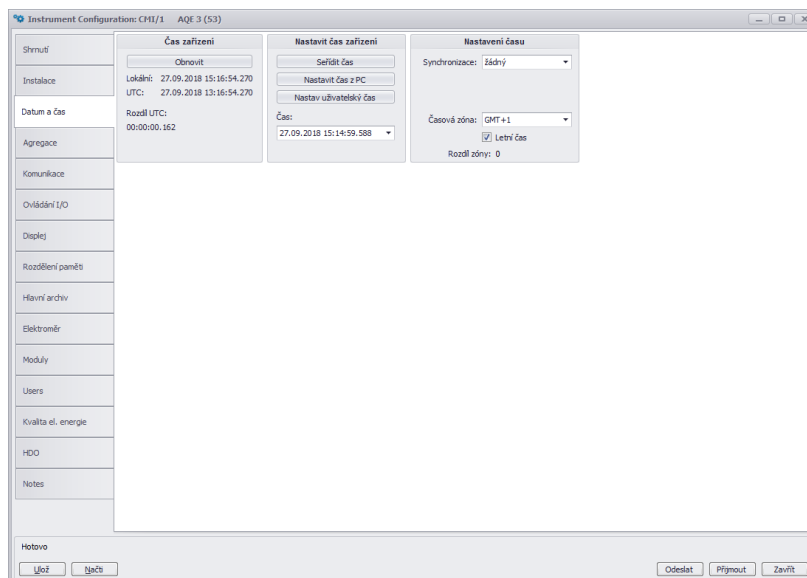

Figure 14: ENVIS.Daq — set date, time and time synchronization options in the device.

- CT ratio — the parameter determines the current range of the device.
 - For standard instruments for indirect measurement with conventional X/5 A and X/1 A transformers, the nominal primary and rated secondary current of the used CT is entered. The default value is 100 A/5 A resp. 1 A.
- *Multiplier U* — this coefficient is rarely changed, but it can be used for corrections when measuring the voltage at the VT output with a non-standard ratio. The default is 1.
- *Multiplier I*:
 - For direct measurement (see eg Fig. 6 set the multiplier value to 1 — default value.
 - For indirect measurement, the value corresponds to the ratio of the current transformer used⁵.

2.4.2 Date and time (fig. 14)

This tab contains settings related to the date and time on your device.



Changes made to device time settings will erase all time-related archives and registers.

The *Instrument Time* panel displays the current date and time in the machine and the difference with the PC time. When you open the tab, it immediately loads the time from the device which is then updated regularly. Pressing the *Refresh* button will reload the current time from the device.

The *Set Instrument Time* panel offers elements for changing the time on your device.

- *Adjust time* — adjusts the time in the device with the time in the PC without deleting archives. This function only adjusts the time if the time difference is less than 6 hours. Time adjustment is achieved by moving the RTC of the instrument to the desired value and:
 - skip forward to skip the necessary number of intervals in the archive
 - when moving backward, the next recording will not be made until the device's time reaches the time set during the adjustment
- *Set time from PC* — sets the time in the device according to the current time on the computer.

⁵For example, if a 100/5 current transformer is used, set *Multiplier I* to $\frac{100}{5} = 20$. Another example of using a multiplier is when we pull a measured wire through a measuring transformer several times to increase the sensitivity of the measurement (the range is reduced accordingly). For 4 turns, *Multiplier I* should be set to $\frac{1}{4} = 0.25$.

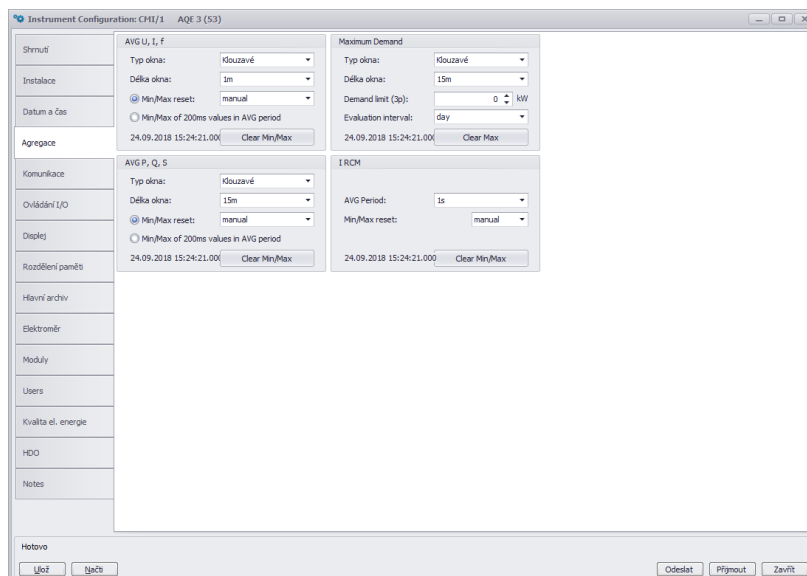

Figure 15: ENVIS.Daq — aggregation setting defines the averaging and evaluation of maximum and minimum values for display and communication.

- *Set user time* — sets the time in the device to the user-specified value.

Time settings panel — sets type of synchronization and how the device interprets and displays the time and date.

- *Synchronization* — this parameter determines how the device synchronizes its time. Supported methods include:
 - *None* — the device does not synchronize the internal clock. This is the default setting.
 - second and minute pulses on selected digital input (PPS on DI, PPM on DI)
 - *NMEA (GPS) on COM* — on selected communication line — communication port for receiving synchronization messages must be correctly set (NMEA can be combined with receiving accurate time signal on digital input),
 - *NTP on ETH* — in the settings it is necessary to enter the IP address of the server, the device sends the first query 5 minutes after the start and then repeats it periodically every hour,
 - *System frequency* synchronization is performed by measuring the network frequency for a period of one month and defining the time deviation therefrom, if this value differs from the current time by more than 40s, the time in the following measurement interval is adjusted.
- *Time zone* — Time zone must be set according to local requirements. The setting is important for the correct interpretation of local time, which determines the current tariff zone allocation of the meter.
- *Daylight Saving* — This parameter can be set to automatically switch local time according to the season (summer or winter time).

2.4.3 Aggregation (averaging, fig. 15)

These settings affect how the values are calculated for special ModBus registers of aggregated values. For devices with a display, it also affects the display of average values, minima and maxima. Parameters of averaging window and method of automatic deletion of recorded extremes are determined separately for primary quantities — voltage, current, frequency and separately for power. PavgMax also has special aggregation settings. Correctly set aggregation allows, in conjunction with the ENVIS application, to evaluate and control quarter-hour and possibly other power peaks.

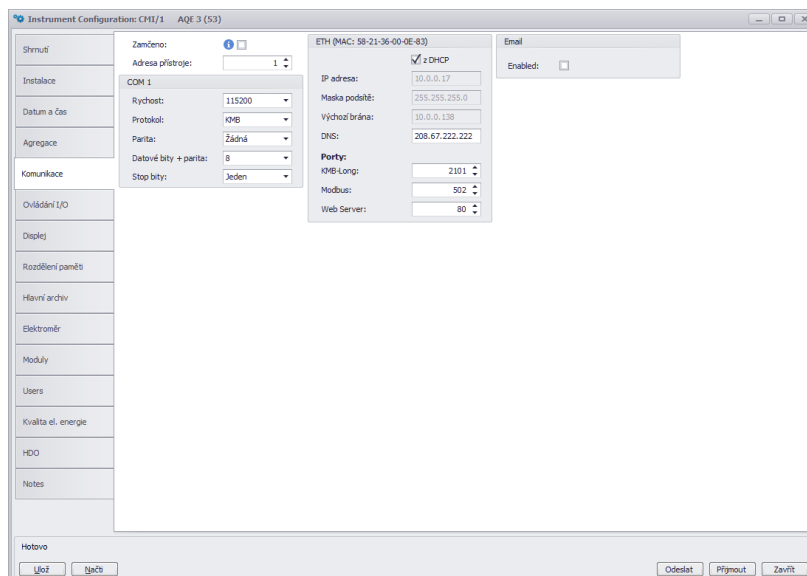

Figure 16: ENVIS.Daq — setting of communication line parameters.

2.4.4 Communication (fig. 16)

The device is always equipped with a USB, Ethernet and RS-485 communication interface for parameterization and data download.

- *Device Address* — Assign a unique address to each device on one serial line.

COM

- *Port speed* — baud-rate of a communication line. The default is 9600 Bd.
- *Protocol* — select default settings for KMB or M-Bus.
- *Parity* — even, odd or none.
- *Data bits + parity* — specifies the number of data bits including parity bits. For 8 bit + parity, select 9. For 8 bit without parity, select 8.
- *Stop Bits* — specifies the number of synchronization bits transmitted by the interface after each character sent.

ETH

- *IP Address* — can be entered either directly or by DHCP to assign the address dynamically from the server.
- *Net Mask* — netmask
- *Default gateway* — set the default gateway on the network.
- *Ports* — each protocol can be assigned a non-standard TCP port. Default settings:
 - *KMB Long* protocol: 2101,
 - *Modbus* protocol: 502,
 - *Web Server*: 80.

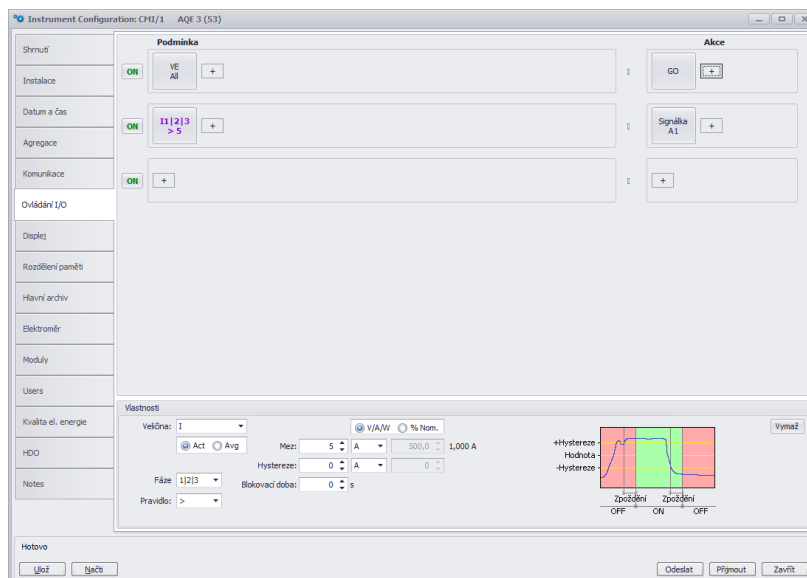

Figure 17: ENVIS.Daq - configuration of programmable inputs and outputs behavior.

2.4.5 I/O Management (fig. 17)

ARTIQ 233 is equipped with four universal digital inputs and outputs. Option without LCD is equipped with two alarm LEDs A1 and A2. As a digital signal entering the equation, it is possible to use the device status or exceeding of the set limit of the measured variable.

- A function that controls any output can be programmed in the device
- Any output can be set as the pulse output of the meter. In this case, either active or reactive energy in both quadrants can be selected as the control variable. It is necessary to set the number of pulses / kWh or kVARh correctly.

2.4.6 Memory (fig. 18)

In this tab, you can use the slider or directly edit the value to redistribute the free capacity of the device's internal memory to selected archives. The reassignment capacity is displayed to the right of the sliders. The capacity of some archives is fixed and cannot be changed by the user. The size of the main archive is adapted to changes in reserved memory for other archives — such as an electricity meter, voltage events, oscillograms, etc.

2.4.7 Setting the main archive (Archive 1, fig. 19).

Options in the archive settings determine which measured values and in what interval should be stored in the device memory:

- *Object* - Naming the measurement location. This is a text string value of up to 32 characters. With this identifier, records are stored in a database or file.
- *Record Name* — Record naming helps to differentiate multiple measurements in one object (e.g. using the ID of the transformer to be measured). Again, this is a text string value of up to 32 characters. With this identifier, records are stored in a database or file.
- *Archive Start*:
 - *Immediately* — records are created immediately after power up.
 - *IO* — the archive record is controlled by the *Archive Control* block set in *I/O Management* (see ??).
- *Recording Interval* — this (aggregate) record interval determines the frequency of storing the measured value record in the archive. The value can be set between 200ms and 24 hours.

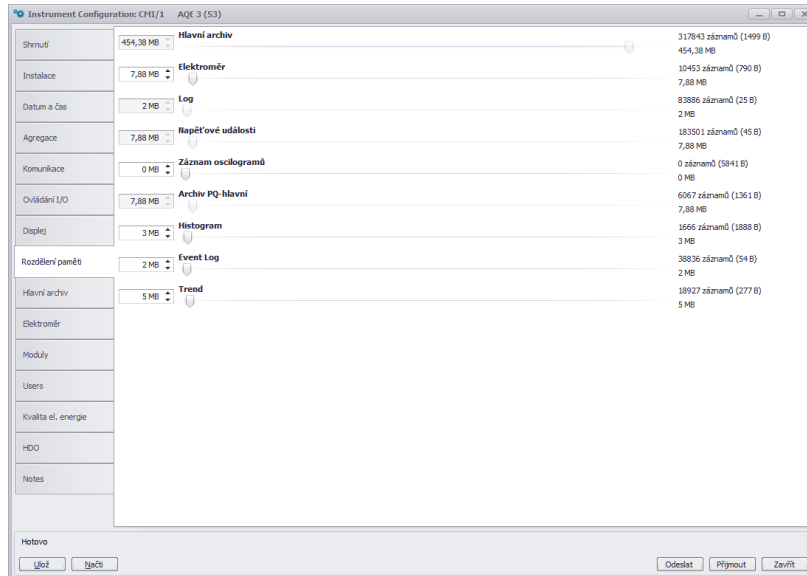

Figure 18: ENVIS.Daq — setting of memory partitioning for individual archives.

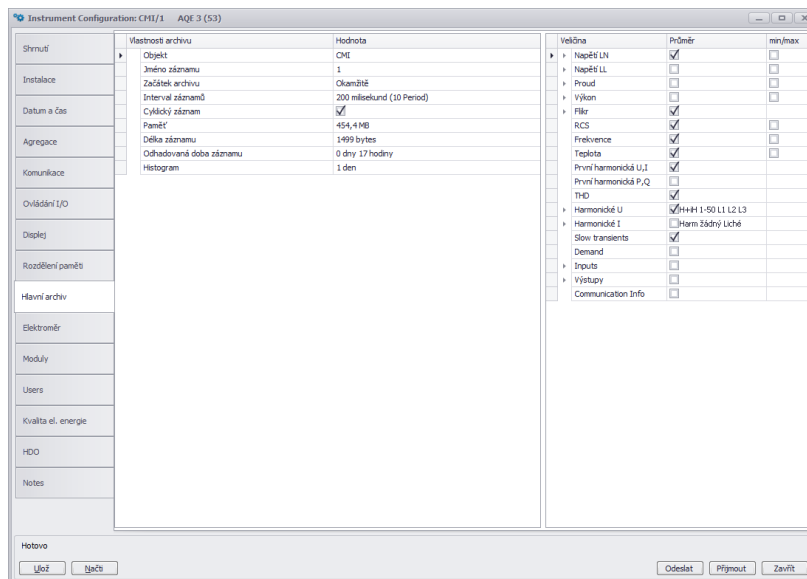

Figure 19: ENVIS.Daq — setting of list of values for main archive.

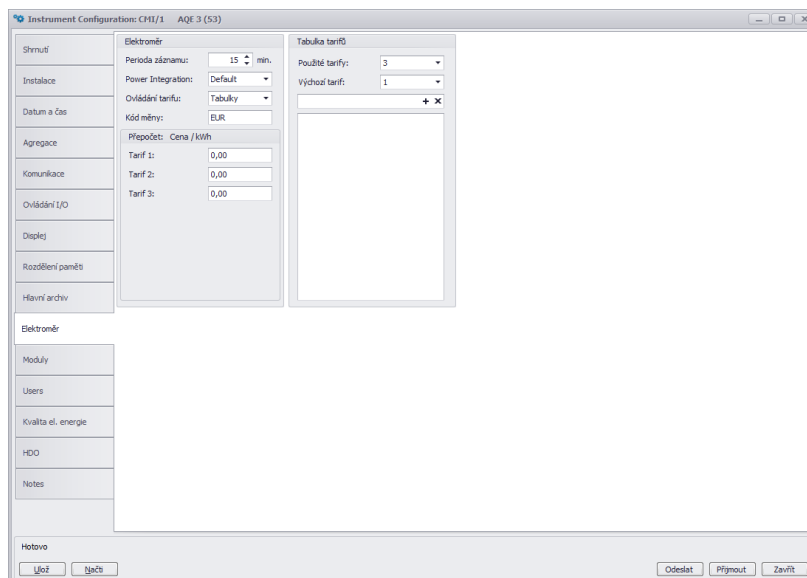

Figure 20: ENVIS.Daq — setting the electricity meter and tariffs and electricity prices.

- *Cycle Recording* — use this switch to specify the device’s behavior when the main archive is full. If this option is not enabled, the device will stop recording when the main archive capacity is full. Otherwise, the record continues, with the newly measured values overwriting the oldest values in the archive. The device then contains the “freshest” record of the length of the main archive.
- *Flash Space* — the dialog also displays the estimated capacity of the main archive for the current configuration.
- *Record Len* — the length of the currently set record in bytes.
- *Estimated Record Time* — based on set values, the instrument displays the estimated recording capacity in days and hours. This information is updated only after writing and reloading of configuration to/from the device.
- *Quantity* — select the quantities to be recorded here. Select the desired ones by checking the appropriate box in the *avg* and *min/max* column.
 - *Power* — ticking the I/E line can be used to select whether the power values for the active power consumption/supply should be recorded separately and inductive/capacitive reactive power separately.
 - *Harmonics* — You can choose whether to record harmonics of voltages and currents.

2.4.8 Electricity meter (fig. 20)

ARTIQ 233 can be used as a standalone four-quadrant meter to simultaneously measure imported, exported, active and reactive energy.

- *Record Interval* — Period of the meter reading (automatic meter readings).
- *Tariff Control* — Set the tariff control. You can choose to use either the *Table* or the *External Input* for tariff switching.
- *Tariff Table* — This table can set daily tariffs for three different prices per hour. The energy for each tariff is recorded separately.
- *Currency Code* — Here you can set the local currency code.
- *Conversion Rate* — Here you can enter price of 1 kWh of energy in each tariff. As a result, it is later possible to see amounts of imported (or exported) energy in local currency instead of direct energy values.

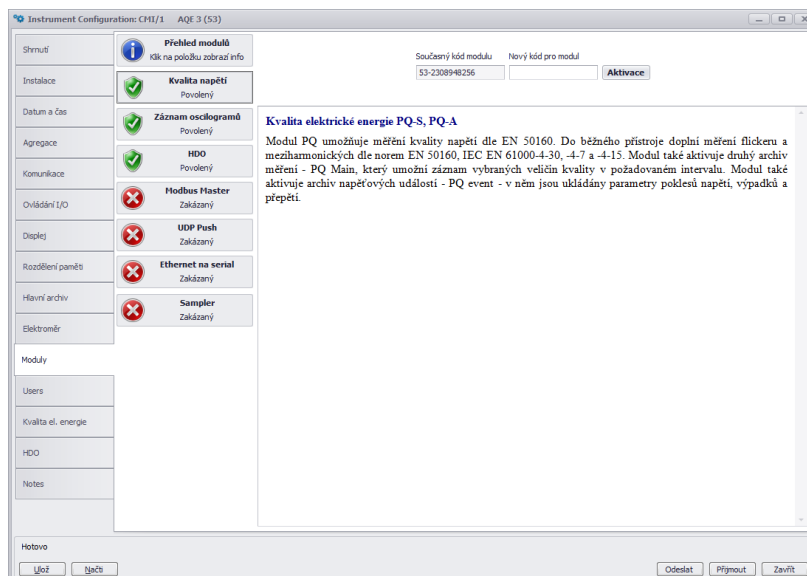

Figure 21: ENVIS.Daq — Activation of special firmware modules.

2.4.9 Modules (fig. 21)

This special device settings tab is only used to activate and deactivate optional firmware modules by entering the correct activation code in the text field and sending it to the device. The activation status of each supported module is signaled.

2.5 Setting measurement identification

This setting is done in the main window of the ENVIS.Daq application. It is used to correctly identify and categorize measurement data while processing on a computer.

- *Object* - Naming the measurement location. This is a text string value of up to 32 characters. With this identifier, records are stored in a database or file.
- *Record Name* — Record naming helps to differentiate multiple measurements in one object (e.g. using the ID of the transformer to be measured). Again, this is a text string value of up to 32 characters. With this identifier, records are stored in a database or file.

To write the *Object* and *Record Name* to the instrument, press the *Send* button in the *Identify* panel. Other parameters displayed in this tab are only informational and cannot be changed. Displayed type of connected device (model, serial number, firmware version and hardware, etc.)

2.6 Transfer of measured data to PC

Connect the device to your computer and start ENVIS.Daq (fig. 10). Select the appropriate communication parameters (as described in 2.4) and connect to the device. Once connected, press *Refresh All* (fig. 12) to load and view the current status of each of the archives.

The Device Information panel contains *Object* and *Record Name* items under which the current record was saved. The time frame for other archives allows you to limit the ranges of other archives by the main archive time interval. You can set the download storage location in the *Destination* area. Currently it can be set to a database or file (in CEA, XLS, PQDIF, ...) format. The checkboxes in the *Archives to download* indicate which archives you are going to download.

To download data from your device, press the *Download selected* button (or *Download All*). The process of data collection is displayed in a new window as shown in figure 22. You can view the downloaded data directly in ENVIS by clicking Open.

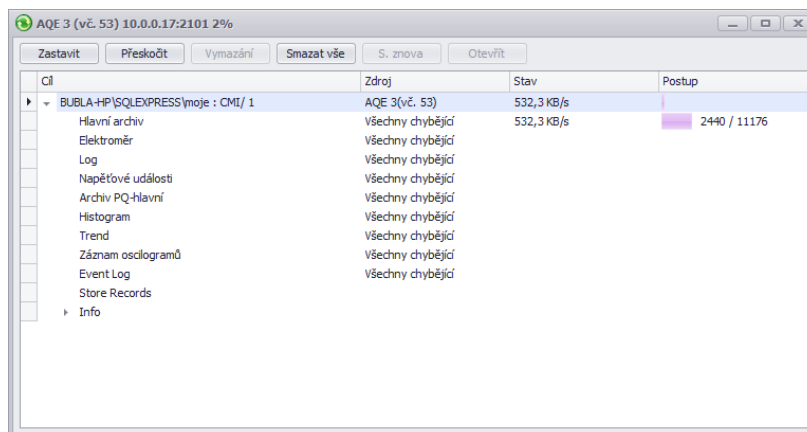

Figure 22: Download progress window.

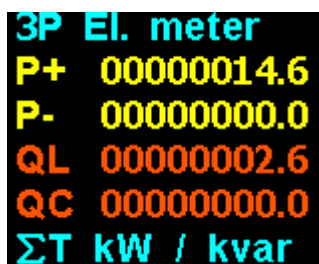

Figure 23: Display of electricity meter readings of the ARTIQ 233 instrument.

2.7 Display of electricity meter reading

ARTIQ 233 has a built-in three-phase, four-quadrant electricity meter with automatic meter readings and registration at various tariffs. The instrument separately registers the active imported EP+ and exported EP- energy. For reactive energy, it registers character — capacitive EQC and inductive EQL resp. capacitive EQC+, EQC- and inductive EQL+, EQL- especially in case of active energy import or export. According to the setting of the meter (chapter 20) it divides the readings into individual tariffs. Primarily it offers the sum values of all phases resp. the total of tariffs. For star-wiring and single-phase wiring, it also registers the values of all energy types in each phase.

For devices with a display, the reading values can be displayed on the screen, see fig. 23. Currently, only the total EP +, EP-, EQL and EQC energy can be read from the instrument screen. Values can be recorded and processed in ENVIS or via the ModBus communication protocol in any other program.

2.8 Embedded Web server

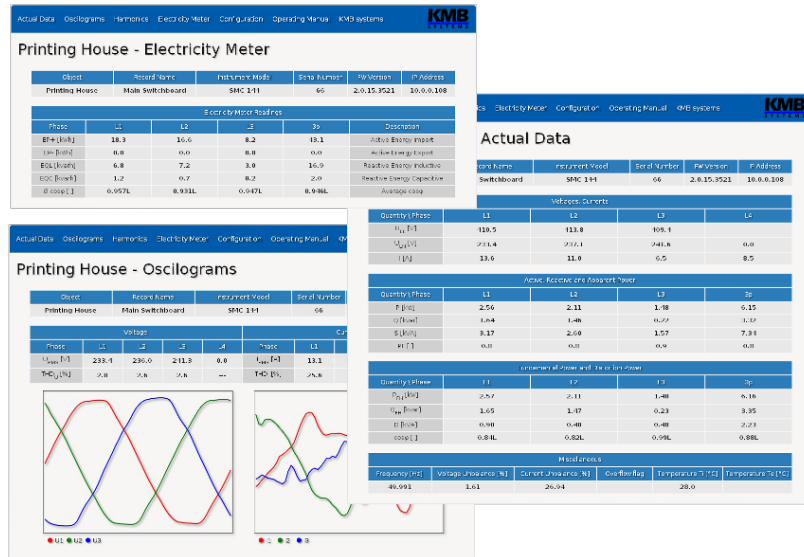

Figure 24: View current data, electricity meter and oscillograms on the instrument's website.

All Ethernet devices have a native webserver built-in as standard, so all the main measured values, counters and instrument settings can be viewed online and using a standard web browser (with HTML 5). It is necessary to enter the appropriate communication parameters in the device and connect the device to the Ethernet network. In the web browser, just enter the appropriate IP address or DNS name.

3 Technical parameters

3.1 Basic parameters

Auxiliary Voltage	
rated auxiliary voltage range	12 ÷ 27 V _{DC}
DC auxiliary voltage range	10 ÷ 30 V _{DC}
power consumption	3 W
overvoltage category	IV
pollution degree	2
maximum operating altitude	2000 m
connection	isolated, polarity free

Other Specifications	
operational temperature	- 25 to 60°C
storage temperature	- 30 to 80°C
operational and storage humidity	< 95 % - non-condensable environment
EMC – generic standards	EN 61326-1 ed. 2 EN 61000-6-2 ed. 3 EN 61000-6-4 ed. 2 EN 61000-6-5
EMC – immunity	EN 61000-4-2 ed. 2 (8 kV / 15 kV) EN 61000-4-3 ed. 3 (10 V/m from 80 MHz to 3 GHz) EN 61000-4-4 ed. 3 (4 kV) EN 61000-4-5 ed. 3 (4 kV / 2 kV) EN 61000-4-6 ed. 4 (10 V from 150 kHz to 80 MHz) EN 61000-4-8 ed. 2 EN 61000-4-18 EN 61000-4-19 EN 61000-3-2 ed. 4 EN 61000-3-3 ed. 3
EMC – emissions	EN 55011 ed. 4, class A EN 55022, class A (not for home use) EN 55032 ed. 2 EN 55016-2-3 ed. 4
safety	EN 61010-1 ed. 2 EN 61010-2-030
communication ports	RS-485 (2400 ÷ 921600 Bd), USB, Fast Ethernet (100 Mbit)
communication protocols	KMB, Ethernet to RS-485 gateway (optional module), Modbus RTU and TCP, Modbus Master (optional module), WEB server, JSON, DHCP, SNTP
display (ARTIQ 233D)	color TFT LCD, 160x128 pixels, 1.8"
status indication (ARTIQ 233)	1 × green LED, 2 × red LED
sampling frequency 50 Hz (60 Hz)	28,8 kHz (28,8 kHz)
resolution of AD converter	16 bit
accuracy of RTC	+/- 0,2 second per day from 0°C to +40°C (+/- 2 ppm) +/- 0,3 second per day from -40°C to +85°C (+/- 3,5 ppm)
capacity of RTC backup battery	> 5 years (at room temperature, without supply voltage applied)
ingress protection front panel whole instrument	IP 40 IP 20
protection class	II
service life	> 15 years
dimensions front panel whole instrument	108 x 45 mm 108 x 90 x 61 mm
weight	max. 0.3 kg

3.2 Measured quantities

Measured Quantities – Voltage	
Frequency	
f_{NOM} – nominal frequency	50 / 60 Hz
measuring range	40 ÷ 70 Hz
uncertainty	± 5 mHz
Voltage	
voltage input option	standard variant („230“)
U_{NOM} (U_{DIN})– rated voltage	50 ÷ 440 V _{AC}
measuring range line-to-neutral	3 ÷ 850 V _{AC}
measuring range line-to-line	5 ÷ 1470 V _{AC}
intrinsic uncertainty ($t_A=23\pm 2^\circ\text{C}$)	+/- 0.05 % of rdg ± +/- 0.01 % of rng
temperature drift	+/- 0.03 % of rdg ± +/- 0.01 % of rng / 10 °C
measurement category	300V CAT IV
permanent overload	4200 V _{AC} (UL–N)
peak overload, 1 second	5600 V _{AC} (UL–N)
burden power (impedance)	< 0.1 VA ($R_i = 6 \text{ M}\Omega$)
Voltage Unbalance	
measuring range	0 ÷ 10 %
measuring uncertainty	± 0.15 %
THDU	
measuring range	0 ÷ 20 %
measuring uncertainty	± 0.1 %
Harmonics up to 128th order (108th order @ 60 Hz)	
reference conditions	other harmonics up to 200 % of class 3 acc. to IEC 61000–2-4 ed.2
measuring range	10 ÷ 200 % of class 3 acc. to IEC 61000–2-4 ed.2
measuring uncertainty	the levels of class I acc. to IEC 61000–4-7 ed.2

Mains Signalling Voltage (with optional firmware module „RCS“ only)	
measuring range	0 ÷ 20 % U_{NOM}
frequency range	100 ÷ 6000 Hz
measuring uncertainty	the levels of class I acc. to IEC 61000–4-7 ed.2

Measured Quantities – Current, Temperature	
Current	
current input option	X/5A
I_{NOM} (I _B) – rated (basic) current	5 (or 1) AAC
measuring range	0.0025 ÷ 10 AAC
intrinsic uncertainty (t _A =23 ±2 °C)	+/- 0.05 % of rdg ± +/- 0.01 % of rng
temperature drift	+/- 0.03 % of rdg ± +/- 0.01 % of rng / 10 °C
measurement category	CAT IV
permanent overload	15 AAC
peak overload 1 second, maximum repetition frequency > 5 minutes	70 AAC
burden power (impedance)	< 1 VA (R _i < 10 mΩ)
Current Unbalance	
measuring range	0 ÷ 100 %
measuring uncertainty	± 0.15 %
Harmonics & Interharmonics up to 128th order (108th order @ 60 Hz)	
reference conditions	other harmonics up to 1000 % of class 3 acc. to IEC 61000–2-4 ed.2
measuring range	500 % of class 3 acc. to IEC 61000–2-4 ed.2
measuring uncertainty	I _h ≤ 10 % I _{NOM} : ± 0.1 % I _{NOM}
	I _h > 10 % I _{NOM} : ± 0.5 % of rdg
THDI	
measuring range	0 ÷ 200 %
measuring uncertainty	THDI ≤ 100 %: ± 0.1 %
	THDI > 100 %: ± 0.1 % of rdg
Temperature (input for external Pt100 RTD)	
measuring range	- 50 ÷ 170°C
measuring uncertainty	± 1 °C (three-wire connection)
Temperature (internal sensor, measured value affected by the instrument power dissipation)	
measuring range	- 40 ÷ 85°C
measuring uncertainty	± 3 °C

999-02317-en

Measured Quantities – Power, Power Factor, Energy	
Active / Reactive Power, Power Factor (PF), cos φ (P_{NOM} = U_{NOM} x I_{NOM})	
reference conditions "A": ambient temperature (t _A) U, I for active power, PF, cos φ for reactive power	23 ± 2 °C U = 80 ÷ 120 % U _{NOM} , I = 1 ÷ 120 % I _{NOM} PF = 1.00 PF = 0.00
act. / react. power uncertainty	± 0.1 % of rdg ± 0.005 % P _{NOM}
PF & cos φ uncertainty	± 0.005
reference conditions "B": ambient temperature (t _A) U, I for active power, PF, cos φ for reactive power	23 ± 2 °C U = 80 ÷ 120 % U _{NOM} , I = 2 ÷ 120 % I _{NOM} PF ≥ 0.5 PF ≤ 0.87
act. / react. power uncertainty	± 0.2 % of rdg ± 0.005 % P _{NOM}
PF & cos φ uncertainty	± 0.005
temperature drift of powers	± 0.05 % of rdg ± 0.02 % P _{NOM} / 10 °C
Energy	
measuring range	corresponds to U & I measuring ranges 4 quadrant energy counters for both active and reactive energies
active energy uncertainty	class 0.2S acc. to EN 62053 – 22
reactive energy uncertainty	class 0.5S acc. to EN 62053 – 24

en-62053-22-24

3.3 Inputs and outputs

Digital Outputs & Digital Inputs: universal 4 DIO	
Digital Outputs	
type	Optically isolated, unipolar (IOx -, IOxC +)
load rating	30 V _{DC} , 40 mA _{DC}
dynamic parameters (pulse output):	S0 - compatible
- pulse duration	50 ms
- gap duration	>= 50 ms
- maximum frequency	10 Hz
Digital Inputs	
type	Optically isolated, unipolar (IOx +, IOxC -)
maximum voltage	30 V _{DC}
voltage for "logical 1"	> 7 V _{DC}
voltage for "logical 0"	< 3 V _{DC}
input current	5 mA @ 12V / 13 mA @ 24V
dynamic par. (pulse counter):	
- pulse/gap duration	>= 0.5 / 0.5 ms
- maximum frequency	1 kHz

3.4 Power quality and energy management

Table 3: IEC 61000-4-30, 61000-4-15, 61000-4-7

Function characteristics according to IEC 61000-4-30 ed. 3				
Function	Class	Uncertainty	Measuring range	Notes
frequency	A	± 10 mHz	40 ÷ 70 Hz	
magnitude of the supply	A	± 0.1 % U _{din}	10 ÷ 200 % U _{din}	
flicker	A	± 5 % of value or $\pm 0,05$	0.2 ÷ 20	2, 4)
dips and swells	A	± 0.1 % U _{din} , ± 1 cycle	5 ÷ 200 % U _{din}	2)
interruptions	A	± 1 cycle	unlimited	2)
unbalance	A	± 0.15 %	0.5 ÷ 10 %	
voltage harmonics & interharmonics 50 Hz (60 Hz)	A	the levels of class I acc. IEC 61000–4-7 ed.2	10÷200 % of cl. 3, 128(108) h acc. IEC 61000–2-4 ed.2	1)
mains signalling voltage	A	the levels of class I acc. IEC 61000–4-7 ed.2	0 ÷ 20 % U _{din} Fmsv: 100 ÷ 3000 Hz	1, 3)

1) ... according to IEC 61000-4-7 ed. 2

2) ... with optional firmware module „PQ A“

3) ... with optional firmware module „RCS“

4) ... class F1 according to IEC 61000-4-15 ed. 2

Table 4: EN 50160

Power Quality acc. to EN 50160 (with optional firmware module „PQ A“ only)	
evaluation period	weekly
Interharmonics up to 128th order (108th order @ 60 Hz)	
reference conditions	other harmonics up to 200 % of class 3 acc. to IEC 61000–2-4 ed.2
measuring range	10 ÷ 100 % of class 3 acc. to IEC 61000–2-4 ed.2
measuring uncertainty	the levels of class I acc. to IEC 61000–4-7 ed.2
Flicker (with optional firmware module „PQ A“ only)	
class	F1 acc. to IEC 61000–4-15 ed. 2
measuring uncertainty	± 5 % of rdg
measuring range	0.2 ÷ 10
Voltage Dips & Swells (with optional firmware module „PQ A“ only)	
measuring uncertainty	+/- 0.1 % of rng
Voltage Interruptions (with optional firmware module „PQ A“ only)	
measuring uncertainty	+/- 0.1 % of rng
duration measuring uncertainty	± 1 cycle
Mains Signalling Voltage	
evaluation period	3s interval

Table 5: IEC 61557-12: Equipment for measuring and monitoring electrical parameters

Instrument characteristics according to IEC 61557-12	
power quality assessment function	PQI-A
classification according to par. 4.3	
direct voltage connection	SD
voltage connection via VT	SS
temperature according to par. 4.5.2.2	K55
humidity + altitude according to par. 4.5.2.3	< 95 % - noncondensation conditions < 2000 m
active power/energy function performance class	0.2

Function characteristics according to IEC 61557-12				
Model „X/5A“, $I_{NOM} = 5 \text{ A}$, $U_{NOM} = 230 \text{ V}$				
Symbol	Function	Class	Measuring range	Notes
P	total effective power	0.2	0 ÷ 24 kW	
QA, QV	total reactive power	1	0 ÷ 24 kvar	
SA, SV	total apparent power	0.2	0 ÷ 24 kVA	
Ea	total active energy	0.2	0 ÷ 24 kWh	
ErA, ErV	total reactive energy	2	0 ÷ 24 kvarh	
EapA, EapV	total apparent energy	0.2	0 ÷ 24 kVAh	
f	frequency	0.02	40 ÷ 70 Hz	
I	phase current	0.1	0.5 ÷ 10 AAC	
IN	neutral current measured	–	–	
Inc	neutral current calculated	0.1	0.5 ÷ 30 AAC	
ULN	line-to-neutral voltage	0.1	40 ÷ 800 VAC	
ULL	line-to-line voltage	0.1	70 ÷ 1400 VAC	
PFA, PFV	power factor	0.5	0 ÷ 1	
Pst, Pit	flicker	2	0.4 ÷ 10	2)
Udip	voltage dips	0.1	10 ÷ 230 VAC	2)
Uswl	voltage swells	0.1	230 ÷ 850 VAC	2)
Utr	transients overvoltage	–	–	
Uint	voltage interruption	0.1	0 ÷ 10 VAC	2)
Unba	voltage unbalance (amp.)	0.2	0 ÷ 10 %	
Unb	voltage unbalance (ph. & amp.)	0.2	0 ÷ 10 %	
Uh	voltage harmonics 50 Hz (60 Hz)	1	up to 128 th (108 th) order	1)
THDu	voltage total harmonic distortion (rel. to fund.)	1	0 ÷ 20 %	1)
THD-Ru	voltage total harmonic distortion (rel. to RMS)	1	0 ÷ 20 %	1)
Ih	current harmonics 50 Hz (60 Hz)	1	up to 128 th (108 th) order	1)
THDi	current total harmonic distortion (rel. to fund.)	1	0 ÷ 200 %	1)
THD-Ri	voltage total harmonic distortion (rel. to RMS)	1	0 ÷ 200 %	1)
Msv	mains signalling voltage	1	0 ÷ 46 VAC	1, 3)

1) ... according to IEC 61000-4-7

2) ... with optional firmware module „PQ A“

3) ... with optional firmware module „RCS“

Function characteristics according to IEC 61557-12				
Model „X/5A“, $I_{NOM} = 1\text{ A}$, $U_{NOM} = 230\text{ V}$				
Symbol	Function	Class	Measuring range	Notes
P	total effective power	0.5	0 ÷ 24 kW	
QA, QV	total reactive power	1	0 ÷ 24 kvar	
SA, SV	total apparent power	0.5	0 ÷ 24 kVA	
Ea	total active energy	0.5	0 ÷ 24 kWh	
ErA, ErV	total reactive energy	0.5	0 ÷ 24 kvarh	
EapA, EapV	total apparent energy	0.5	0 ÷ 24 kVAh	
f	frequency	0.02	40 ÷ 70 Hz	
I	phase current	0.2	0.1 ÷ 10 AAC	
IN	neutral current measured	–	–	
Inc	neutral current calculated	0.2	0.1 ÷ 30 AAC	
ULN	line-to-neutral voltage	0.1	40 ÷ 800 VAC	
ULL	line-to-line voltage	0.1	70 ÷ 1400 VAC	
PFA, PFV	power factor	1	0 ÷ 1	
Pst, Pit	flicker	2	0.4 ÷ 10	2)
Udip	voltage dips	0.1	10 ÷ 230 VAC	2)
Uswl	voltage swells	0.1	230 ÷ 850 VAC	2)
Utr	transients overvoltage	–	–	
Uint	voltage interruption	0.1	0 ÷ 10 VAC	2)
Unba	voltage unbalance (amp.)	0.2	0 ÷ 10 %	
Unb	voltage unbalance (ph. & amp.)	0.2	0 ÷ 10 %	
Uh	voltage harmonics 50 Hz (60 Hz)	1	up to 128 th (108 th) order	1)
THDu	voltage total harmonic distortion (rel. to fund.)	1	0 ÷ 20 %	1)
THD-Ru	voltage total harmonic distortion (rel. to RMS)	1	0 ÷ 20 %	1)
Ih	current harmonics 50 Hz (60 Hz)	2	up to 128 th (108 th) order	1)
THDi	current total harmonic distortion (rel. to fund.)	2	0 ÷ 200 %	1)
THD-Ri	voltage total harmonic distortion (rel. to RMS)	2	0 ÷ 200 %	1)
Msv	mains signalling voltage	1	0 ÷ 46 VAC	1, 3)

1) ... according to IEC 61000-4-7

2) ... with optional firmware module „PQ A“

3) ... with optional firmware module „RCS“

4 Maintenance, service and warranty

Maintenance The Network Analyzer and meter ARTIQ 233 does not require any special maintenance. For reliable operation, it is only necessary to adhere to the specified operating conditions and not to expose it to rough handling and exposure to water or various chemicals that could cause damage. It is advisable to clean the product regularly (preferably during a preventive inspection of the entire system) in the switched off state with a dry cloth or brush so that the ventilation openings and clamps remain clean.

The lithium battery installed in the instrument is capable of backing up memory and RTC for approximately 5 years without a power supply at an average temperature of 20°C and a typical load current in the instrument ($< 10 \mu A$). If the battery is discharged, it is necessary to send the instrument to the manufacturer for battery replacement.

Service In case of product failure, a warranty must be claimed with the manufacturer at:

K M B systems, s. r. o.
Tř. dr. M. Horákové 559
460 05 Liberec 7
Czech republic
Tel.: +420 485 130 314
E-mail: kmb@kmb.cz
Web: www.kmb.cz

The product must be properly packed to avoid shipping damage. A description of the fault must be provided with the product.

If warranty repair is claimed, the warranty card must also be sent. If an out-of-warranty repair is required, an order for this repair must be attached.

Warranty card: The device is warranted for a period of 24 months from the date of purchase, but no longer than 30 months from the manufacturer's delivery date. Defects that arise within these time limits demonstrably due to defective design, faulty construction or unsuitable material will be repaired free of charge by the manufacturer or authorized service organization.

The warranty also expires during the warranty period if the user performs unauthorized modifications or changes on the device, if the device connects to incorrectly selected values, if the device has been violated by unauthorized falls or improper handling, or if it has been operated in contrary to the specified technical parameters.

Product type:	Serial number:
Delivery date:	Checkout control:
		Manufacturer's stamp:
Date of sale:	Seller's stamp: